

SMD ■ MID Power LED 50-217S/KKE-BXXXX32Z6/SZM/2T

MTC V.3



4000K 26Lm 指定使用 HC1025 芯片,
4000K 28Lm 指定使用 HC1128 芯片,
4000K 30Lm 使指定用 HC1734 芯片
4000K 32Lm 使指定用 SA2235 芯片

Features

- PLCC-2 package
- Top view white LED
- High luminous intensity output
- Wide viewing angle
- Pb-free
- ANSI Binning
- The product itself will remain within RoHS compliant version.
- Compliance with EU REACH.
- Compliance Halogen Free .(Br<900ppm,Cl<900ppm,Br+Cl<1500ppm)

Description

The Everlight 50-217S package has high efficacy, high CRI, low power consumption, wide viewing angle and a compact form factor. These features make this package an ideal LED for all lighting applications.

Applications

- General lighting
- Decorative and Entertainment Lighting
- Indicators
- Illumination
- Switch lights

50-217S/KKE-BXXXX32Z6/SZM/2T

MTC 改版歷史

版本	修改內容	改版日期
1	初版制定	2019.05.05
2	增加 4000K 32lm 規格	2019.06.06
3	4000K 32lm 規格增加 2.7-2.8V 電壓檔	2019.07.05

Product Number Explanation

50-217S / K KE -B XX XX XX Z6 / SZM/2T

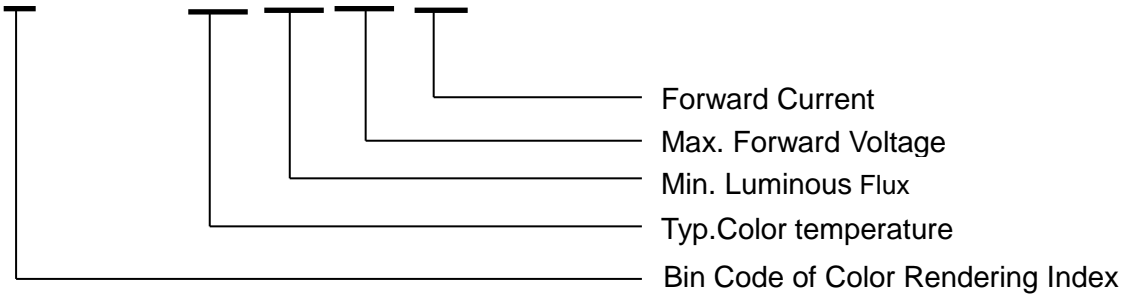

Table of Color Rendering Index

Symbol	Description
M	CRI(Min.) : 60
N	CRI(Min.) : 65
L	CRI(Min.) : 70
Q	CRI(Min.) : 75
K	CRI(Min.) : 80
P	CRI(Min.) : 85
H	CRI(Min.) : 90

Note:
 Tolerance of Color Rendering Index: -1~+3

Table of Forward Current Index

Symbol	Description
Z6	I _F :60mA

Table of Forward Voltage Index

Symbol	Description
32	3.2V max

Example:
 50-217S/KKE-B402632Z6/SZM/2T

CRI	80.5(Min.)
CCT	4000K
Flux	26lm min
V _F	3.2V max
I _F	60mA

Mass Production List

Series For 4000K 26Lm

	Product	CRI Min. ⁽¹⁾	R9 Min. ⁽¹⁾	CCT(K)	Φ(lm) Min. ⁽²⁾
S10C015823	50-217S/KKE-B302432Z6/SZM/2T	80	0	3000K	24
S10C015824	50-217S/KKE-B352432Z6/SZM/2T	80	0	3500K	24
S10C015825	50-217S/KKE-B402632Z6/SZM/2T	80	0	4000K	26
S10C015826	50-217S/KKE-B432632Z6/SZM/2T	80	0	4300K	26
S10C015827	50-217S/KKE-B502632Z6/SZM/2T	80	0	5000K	26
S10C015828	50-217S/KKE-B572632Z6/SZM/2T	80	0	5700K	26
S10C015829	50-217S/KKE-B632632Z6/SZM/2T	80	0	6300K	26
S10C015830	50-217S/KKE-B652632Z6/SZM/2T	80	0	6500K	26

Series For 4000K 28Lm

	Product	CRI Min. ⁽¹⁾	R9 Min. ⁽¹⁾	CCT(K)	Φ(lm) Min. ⁽²⁾
S10C015831	50-217S/KKE-B302632Z6/SZM/2T	80	0	3000K	26
S10C015832	50-217S/KKE-B352632Z6/SZM/2T	80	0	3500K	26
S10C015833	50-217S/KKE-B402832Z6/SZM/2T	80	0	4000K	28
S10C015834	50-217S/KKE-B432832Z6/SZM/2T	80	0	4300K	28
S10C015835	50-217S/KKE-B502832Z6/SZM/2T	80	0	5000K	28
S10C015836	50-217S/KKE-B572832Z6/SZM/2T	80	0	5700K	28
S10C015837	50-217S/KKE-B632832Z6/SZM/2T	80	0	6300K	28
S10C015838	50-217S/KKE-B652832Z6/SZM/2T	80	0	6500K	28

Series For 4000K 30Lm

	Product	CRI Min. ⁽¹⁾	R9 Min. ⁽¹⁾	CCT(K)	Φ(lm) Min. ⁽²⁾
S10C015839	50-217S/KKE-B302832Z6/SZM/2T	80	0	3000K	28
S10C015840	50-217S/KKE-B352832Z6/SZM/2T	80	0	3500K	28
S10C015841	50-217S/KKE-B403032Z6/SZM/2T	80	0	4000K	30
S10C015842	50-217S/KKE-B433032Z6/SZM/2T	80	0	4300K	30
S10C015843	50-217S/KKE-B503032Z6/SZM/2T	80	0	5000K	30
S10C015844	50-217S/KKE-B573032Z6/SZM/2T	80	0	5700K	30
S10C015845	50-217S/KKE-B633032Z6/SZM/2T	80	0	6300K	30
S10C015846	50-217S/KKE-B653032Z6/SZM/2T	80	0	6500K	30

Series For 4000K 32Lm

	Product	CRI Min. ⁽¹⁾	R9 Min. ⁽¹⁾	CCT(K)	Φ(lm) Min. ⁽²⁾
S10C015949	50-217S/KKE-B303032Z6/SZM/2T	80	0	3000K	30
S10C015950	50-217S/KKE-B353032Z6/SZM/2T	80	0	3500K	30
S10C015951	50-217S/KKE-B403232Z6/SZM/2T	80	0	4000K	32
S10C015952	50-217S/KKE-B433232Z6/SZM/2T	80	0	4300K	32
S10C015953	50-217S/KKE-B503232Z6/SZM/2T	80	0	5000K	32
S10C015954	50-217S/KKE-B573232Z6/SZM/2T	80	0	5700K	32
S10C015955	50-217S/KKE-B633232Z6/SZM/2T	80	0	6300K	32
S10C015956	50-217S/KKE-B653232Z6/SZM/2T	80	0	6500K	32

Notes:

1. Tolerance of Color Rendering Index: -1~+3
2. Tolerance of Luminous flux: ±5%.
3. 亮度和色點(x, y)出貨值以工廠對校深圳辦的標準進行調整後生產。
4. 4000K 26Lm 指定使用 HC1025 芯片, 4000K 28Lm 指定使用 HC1128 芯片, 4000K 30Lm 使指定用 HC1734 芯片, 4000K 32Lm 使指定用 SA2235 芯片

Device Selection Guide

Chip Materials	Emitted Color	Resin Color
InGaN	Cool White Neutral White Warm White	Water Clear

Absolute Maximum Ratings (T_{Soldering}=25°C)

Parameter	Symbol	Rating	Unit
Forward Current	I _F	75	mA
Peak Forward Current (Duty 1/10 @10ms)	I _{FP}	150	mA
Power Dissipation	P _d	250	mW
Operating Temperature	T _{opr}	-40 ~ +85	°C
Storage Temperature	T _{stg}	-40 ~ +100	°C
Thermal Resistance (Junction / Soldering point)	R _{th J-S}	32	°C/W
Junction Temperature	T _j	115	°C
Soldering Temperature	T _{sol}	Reflow Soldering : 260 °C for 5sec. Hand Soldering : 350 °C for 3 sec.	

Note:

The products are sensitive to static electricity and must be carefully taken when handling products

Electro-Optical Characteristics (T_{Soldering}=25°C)

Parameter	Symbol	Min.	Typ.	Max.	Unit	Condition
Luminous Flux ₍₁₎	Φ	24	-----	-----	lm	I _F =60mA
Forward Voltage ₍₂₎	V _F	2.7	-----	3.2	V	I _F =60mA
Color Rendering Index ₍₃₎	R _a	80	-----	-----		I _F =60mA
	R ₉	0	-----	-----		I _F =60mA
Viewing Angle	2θ _{1/2}	-----	120	-----	deg	I _F =60mA
Reverse Current	I _R	-----	-----	1	μA	V _R =5V

Notes:

1. Tolerance of Luminous flux: ±5%.
2. Tolerance of Forward Voltage: ±0.05V.
3. Tolerance of Color Rendering Index: -1~+3

5. 亮度和色點(x, y)出貨值以工廠對校深圳辦的標準進行調整後生產。

Bin Range of Luminous Flux

Bin Code	Min.	Max.	Unit	Condition
2426	24	26	lm	I _F =60mA
2628	26	28		
2830	28	30		
3032	30	32		
3234	32	34		
3436	34	36		
3638	36	38		

Note:

Tolerance of Luminous flux: ±5%.

亮度和色點(x, y)出貨值以工廠對校深圳辦的標準進行調整後生產。

Bin Range of Forward Voltage

Series For 4000K 26Lm

Group	Bin Code	Min.	Max.	Unit	Condition
2832	35	2.8	2.9	V	I _F =60mA
	36	2.9	3.0		
	37	3.0	3.1		
	38	3.1	3.2		

Series For 4000K 28Lm

Group	Bin Code	Min.	Max.	Unit	Condition
2832	35	2.8	2.9	V	I _F =60mA
	36	2.9	3.0		
	37	3.0	3.1		
	38	3.1	3.2		

Series For 4000K 30Lm

Group	Bin Code	Min.	Max.	Unit	Condition
2832	35	2.8	2.9	V	I _F =60mA
	36	2.9	3.0		
	37	3.0	3.1		
	38	3.1	3.2		

Series For 4000K 32Lm

Group	Bin Code	Min.	Max.	Unit	Condition
2732	34	2.7	2.8	V	I _F =60mA
	35	2.8	2.9		
	36	2.9	3.0		
	37	3.0	3.1		
	38	3.1	3.2		

Note:

Tolerance of Forward Voltage: $\pm 0.05V$.

**The C.I.E. 1931 Chromaticity Diagram
 3000K**

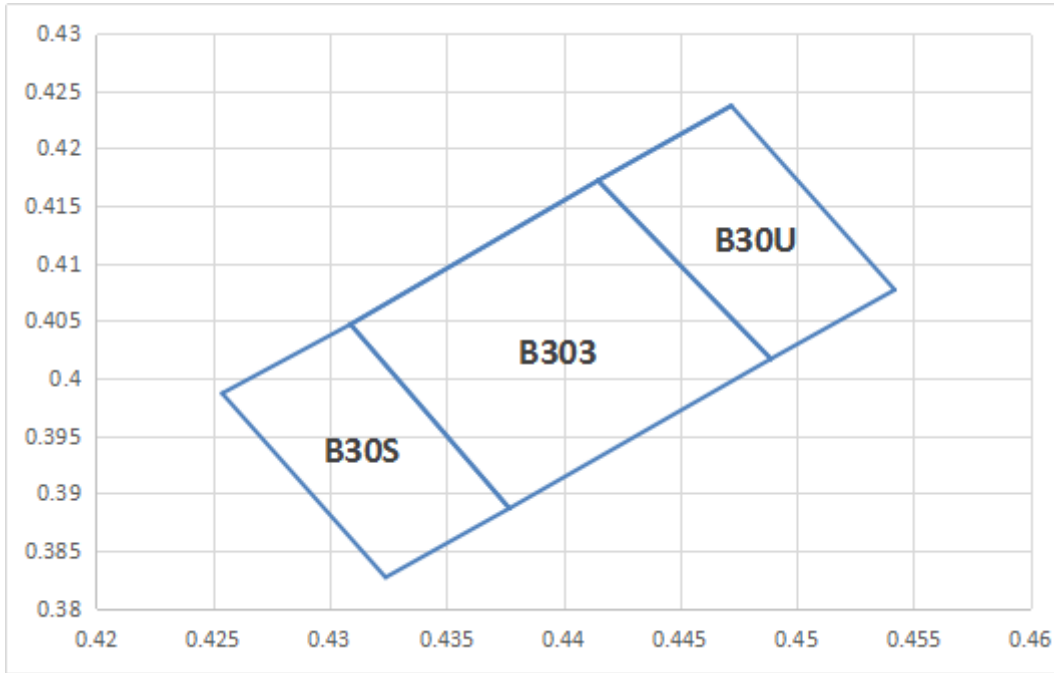

Bin Range of Chromaticity Coordinates

坐标点								
B30U	0.4472	0.4237	B303	0.4415	0.4172	B30S	0.4309	0.4047
	0.4415	0.4172		0.4309	0.4047		0.4254	0.3987
	0.4489	0.4017		0.4377	0.3887		0.4324	0.3827
	0.4542	0.4077		0.4489	0.4017		0.4377	0.3887
	0.4472	0.4237		0.4415	0.4172		0.4309	0.4047
配BIN 方案: B30S: B30U=1:1								

The C.I.E. 1931 Chromaticity Diagram
3500K

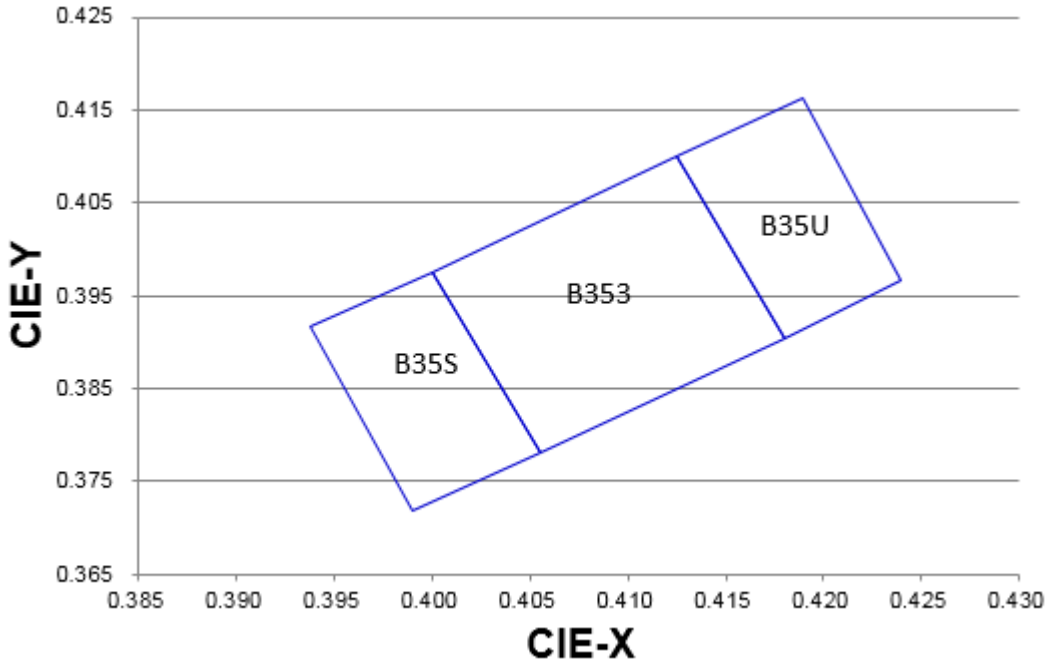

Bin Range of Chromaticity Coordinates

坐标点								
B35U	0.413	0.41	B353	0.406	0.378	B35S	0.406	0.378
	0.418	0.391		0.4	0.398		0.4	0.398
	0.424	0.397		0.413	0.41		0.394	0.392
	0.419	0.416		0.418	0.391		0.399	0.372
	0.413	0.41		0.406	0.378		0.406	0.378
配 BIN 方案: B35S: B35U=1:1								

**The C.I.E. 1931 Chromaticity Diagram
 4000K**

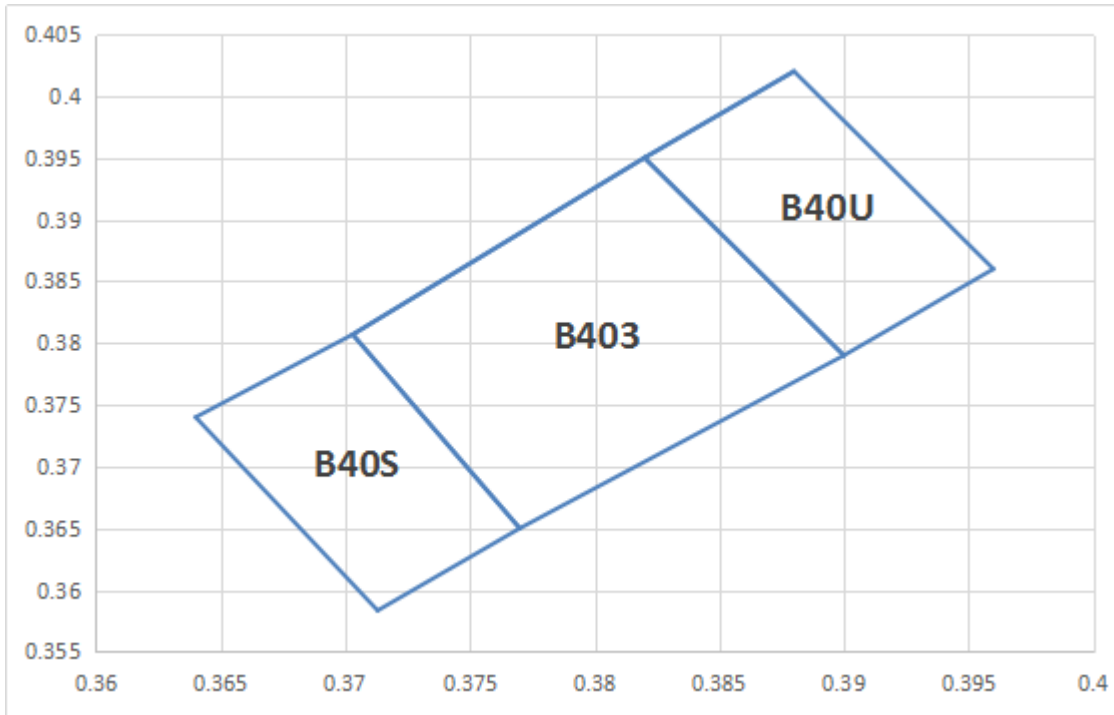

Bin Range of Chromaticity Coordinates

坐标点								
B40U	0.388	0.402	B403	0.382	0.395	B40S	0.3703	0.3807
	0.382	0.395		0.3703	0.3807		0.364	0.374
	0.39	0.379		0.377	0.365		0.3713	0.3584
	0.396	0.386		0.39	0.379		0.377	0.365
	0.388	0.402		0.382	0.395		0.3703	0.3807
配 BIN 方案: B40S: B40U=1:1								

The C.I.E. 1931 Chromaticity Diagram
 4300K

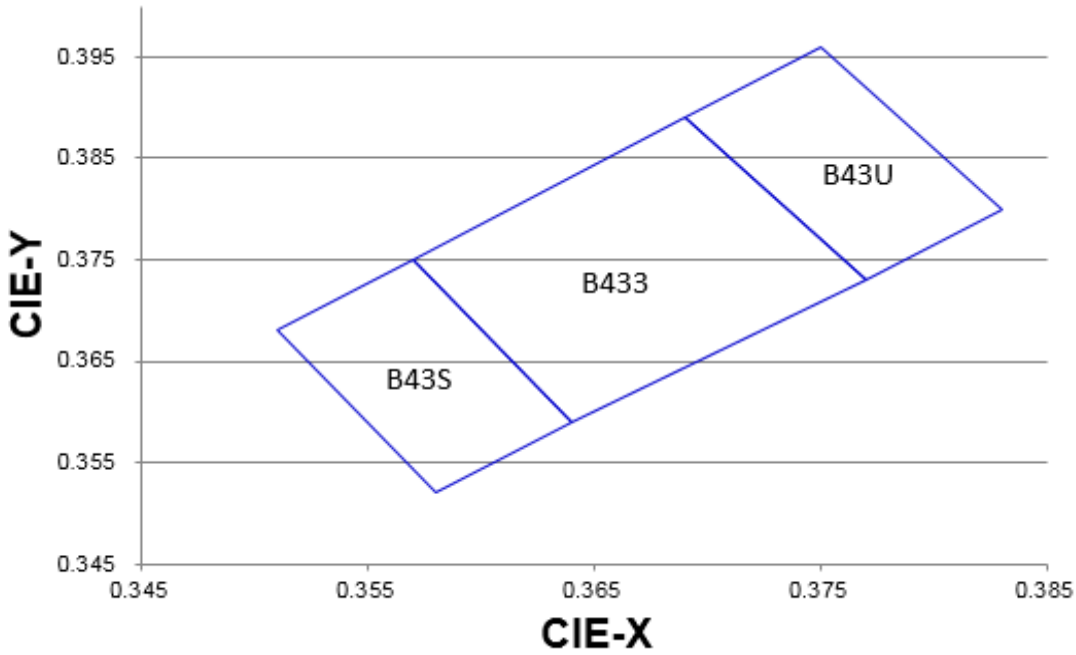

Bin Range of Chromaticity Coordinates

坐标点								
B43U	0.375	0.396	B433	0.369	0.389	B43S	0.357	0.375
	0.369	0.389		0.357	0.375		0.351	0.368
	0.377	0.373		0.364	0.359		0.358	0.352
	0.383	0.38		0.377	0.373		0.364	0.359
	0.375	0.396		0.369	0.389		0.357	0.375
配 BIN 方案: B43S: B43U=1:1								

**The C.I.E. 1931 Chromaticity Diagram
 5000K**

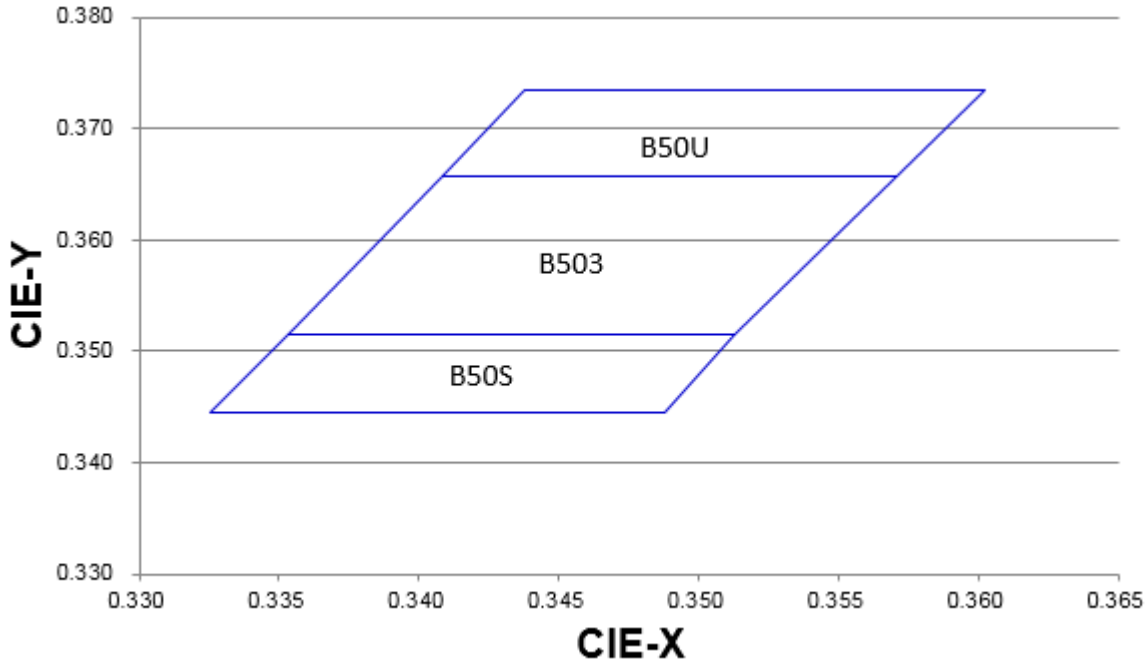

Bin Range of Chromaticity Coordinates

坐标点								
B50U	0.3438	0.3735	B503	0.3408	0.3657	B50S	0.3353	0.3515
	0.3408	0.3657		0.3353	0.3515		0.3325	0.3445
	0.35705	0.3657		0.3513	0.3515		0.3488	0.3445
	0.3602	0.3735		0.35705	0.3657		0.3513	0.3515
	0.3438	0.3735		0.3408	0.3657		0.3353	0.3515
配BIN 方案: B50S: B50U=1:1								

The C.I.E. 1931 Chromaticity Diagram
 5700K

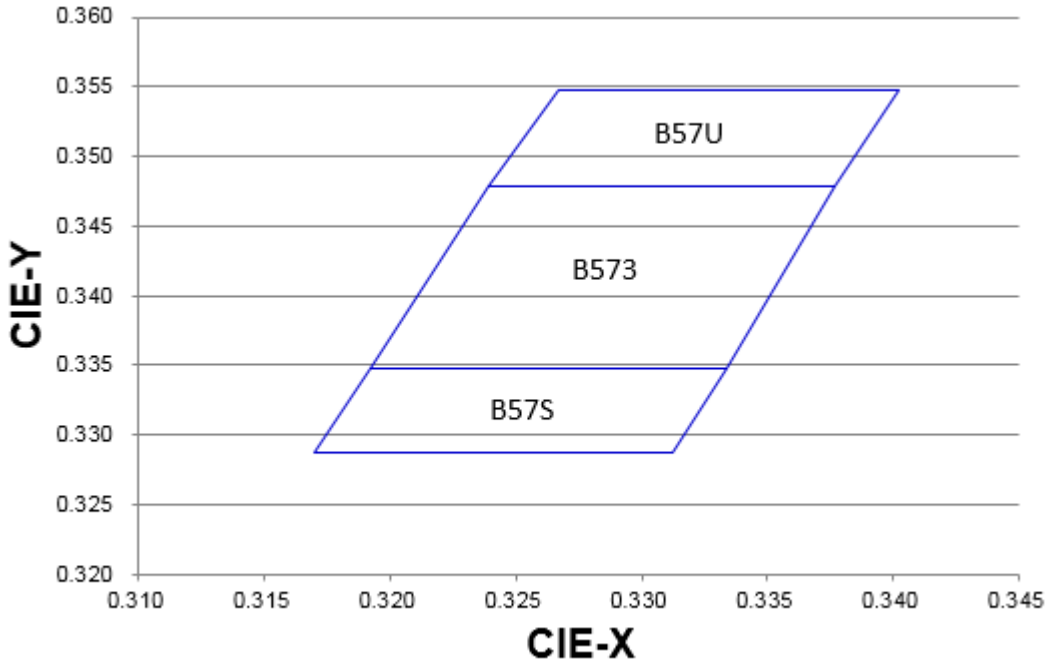

Bin Range of Chromaticity Coordinates

坐标点								
B57U	0.327	0.355	B573	0.324	0.348	B57S	0.319	0.335
	0.324	0.348		0.319	0.335		0.317	0.329
	0.338	0.348		0.333	0.335		0.331	0.329
	0.34	0.355		0.338	0.348		0.333	0.335
	0.327	0.355		0.324	0.348		0.319	0.335
配BIN 方案: B57S: B57U=1:1								

**The C.I.E. 1931 Chromaticity Diagram
 6300K**

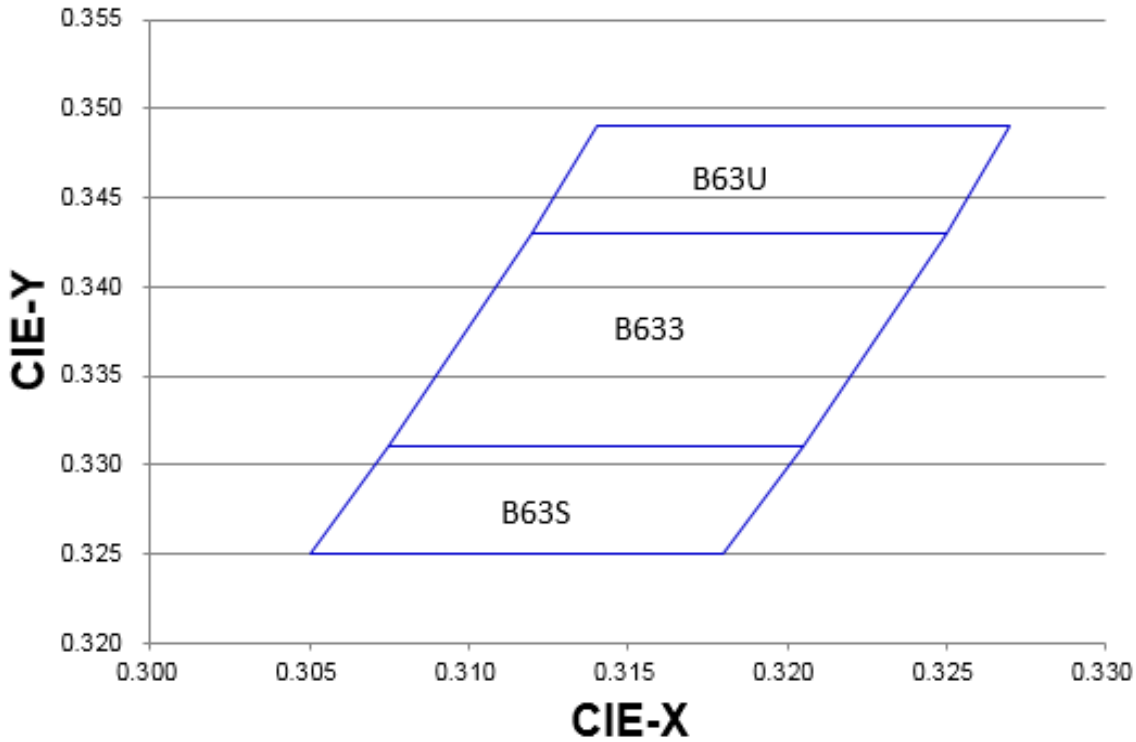

Bin Range of Chromaticity Coordinates

坐标点								
B63U	0.314	0.349	B633	0.312	0.343	B63S	0.3075	0.331
	0.312	0.343		0.3075	0.331			
	0.325	0.343		0.3205	0.331			
	0.327	0.349		0.325	0.343			
	0.314	0.349		0.312	0.343			
配 BIN 方案: B63S: B63U=1:1							0.3205	0.331
							0.318	0.325

The C.I.E. 1931 Chromaticity Diagram
 6500K

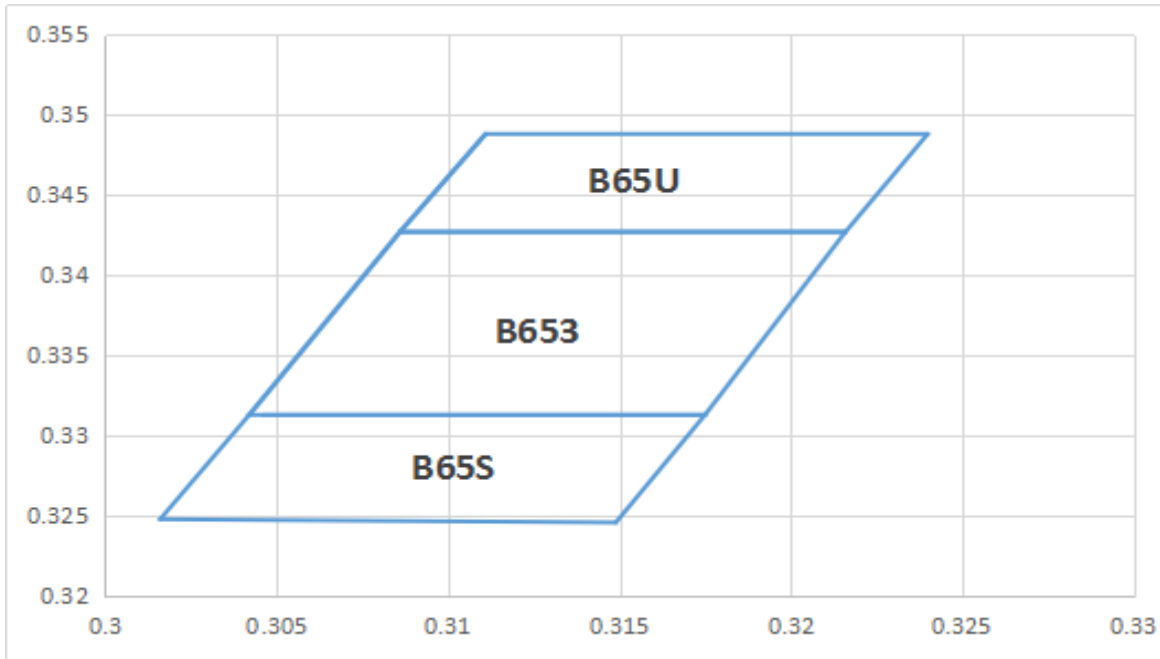

Bin Range of Chromaticity Coordinates

坐标点								
B65U	0.3111	0.3488	B653	0.3086	0.3427	B65S	0.3042	0.3313
	0.3086	0.3427		0.3042	0.3313		0.3016	0.3248
	0.3216	0.3427		0.3175	0.3313		0.3149	0.3246
	0.324	0.3488		0.3216	0.3427		0.3175	0.3313
	0.3111	0.3488		0.3086	0.3427		0.3046	0.3313
配 BIN 方案: B65S: B65U=1:1								

Notes:

1. The value is based on driving current by 60mA.
2. Tolerance of Chromaticity Coordinates: ± 0.004 .

Spectrum Distribution

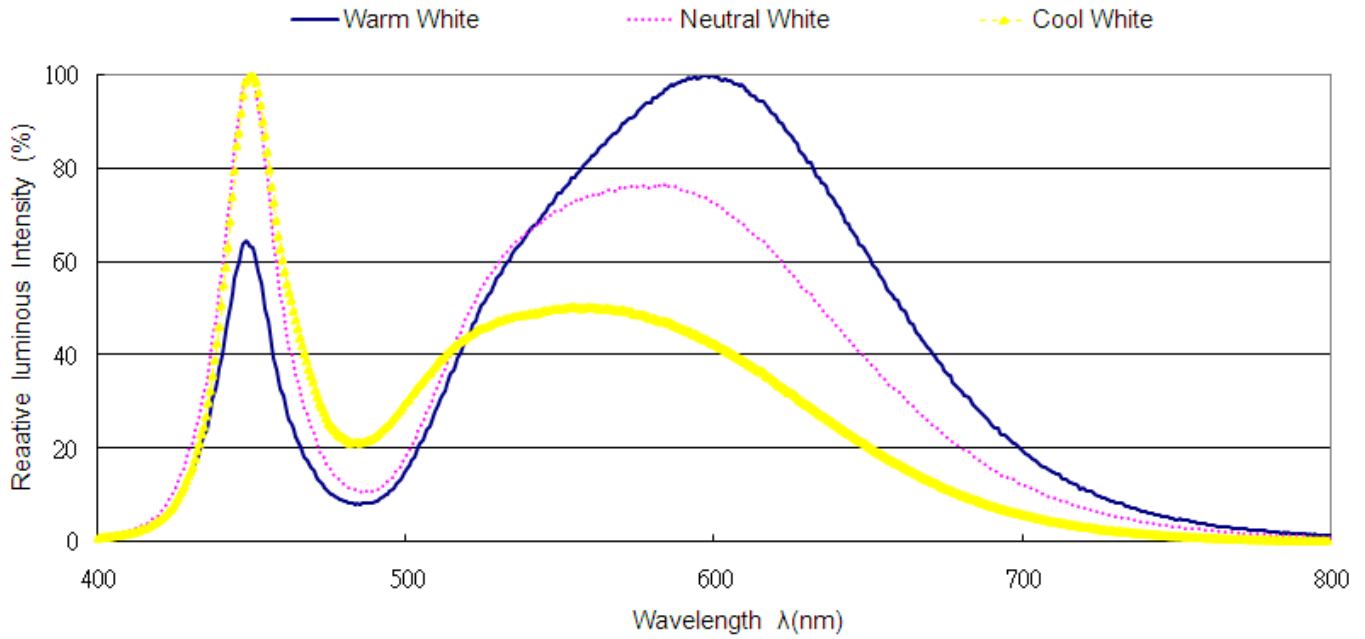

Typical Electro-Optical Characteristics Curves

Fig.1 – Forward Voltage Shift vs. Junction Temperature

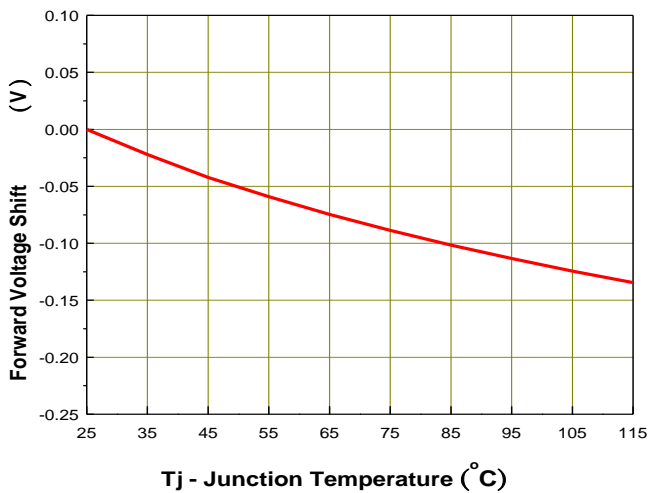
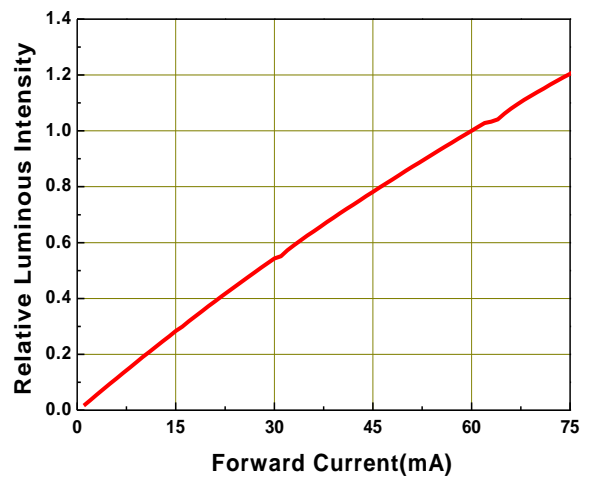

Fig.2 - Relative Luminous Intensity vs. Forward Current



Typical Electro-Optical Characteristics Curves

Fig.3 - Relative Luminous Intensity vs. Junction Temperature

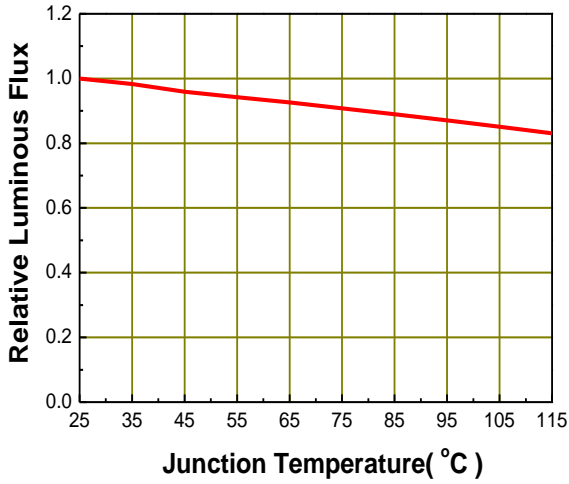

Fig.4 - Forward Current vs. Forward Voltage

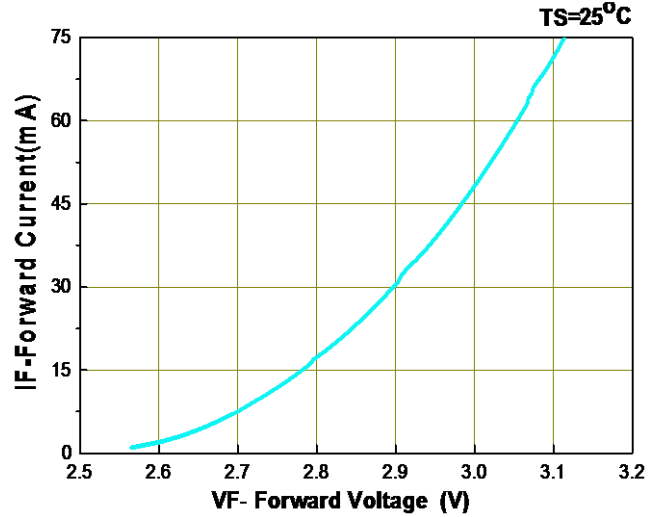

Fig.5 – Max. Driving Forward Current vs. Soldering Temperature

$R_{th\ j-s}=32^{\circ}C/W$

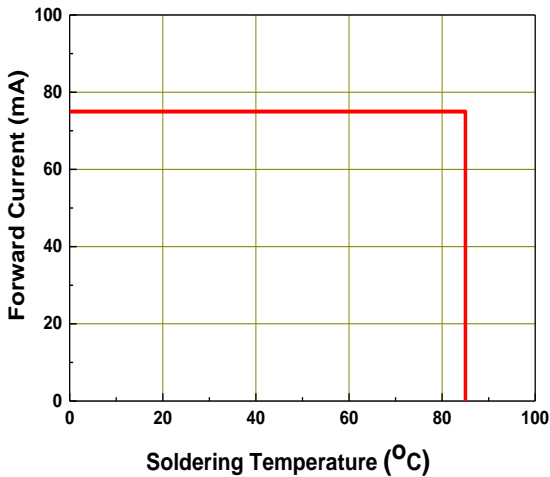
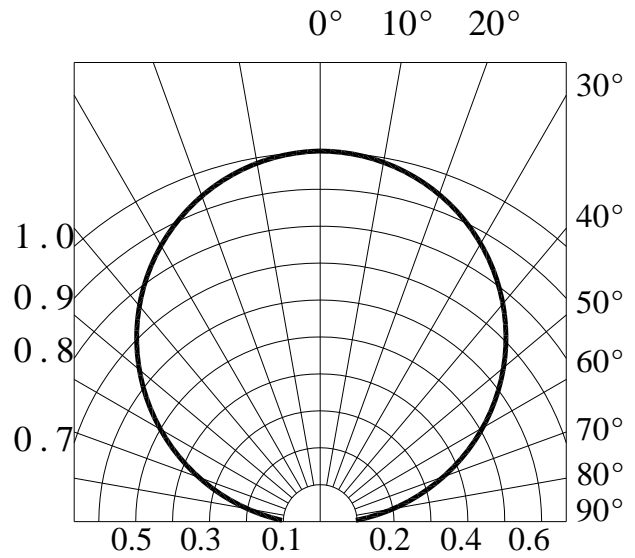
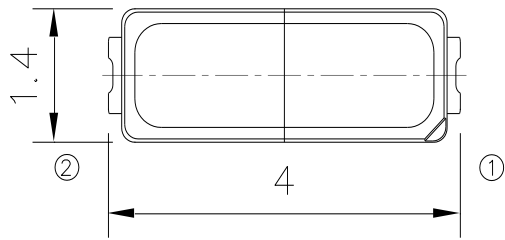

Fig.6 – Radiation Diagram



Package Dimension



Polarity

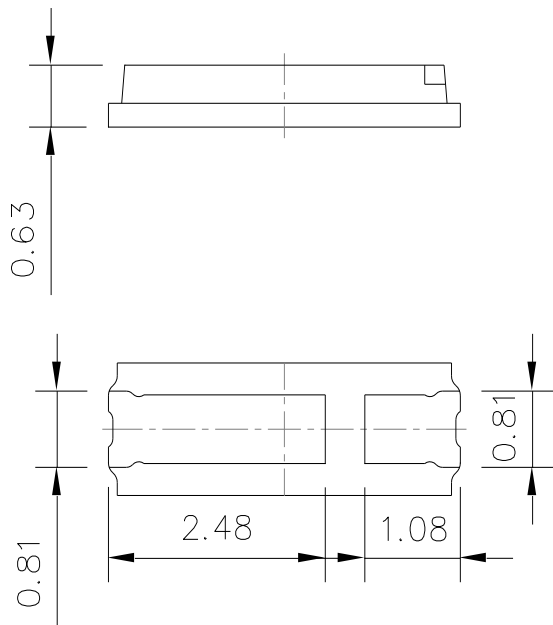

Bot. view

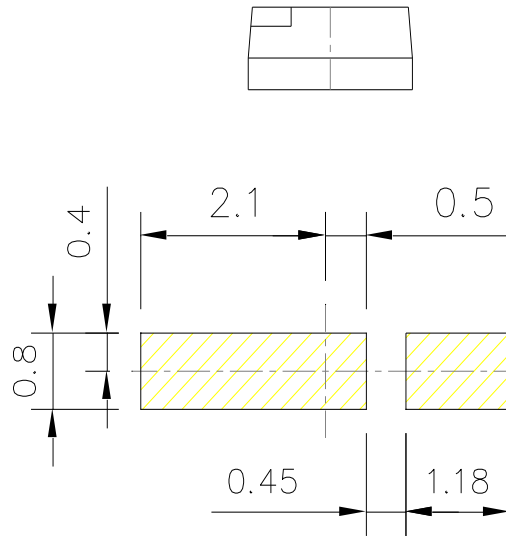

Soldering patterns

Note:
Tolerance unless mentioned is ± 0.15 mm; Unit = mm

Moisture Resistant Packing Materials

Label Explanation

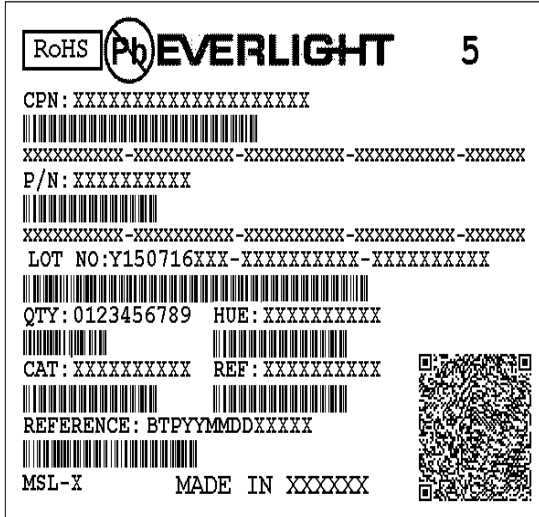

- CPN: Customer's Product Number
- P/N: Product Number
- QTY: Packing Quantity
- CAT: Luminous Intensity Rank
- HUE: Dom. Wavelength Rank
- REF: Forward Voltage Rank
- LOT No: Lot Number

Reel Dimensions

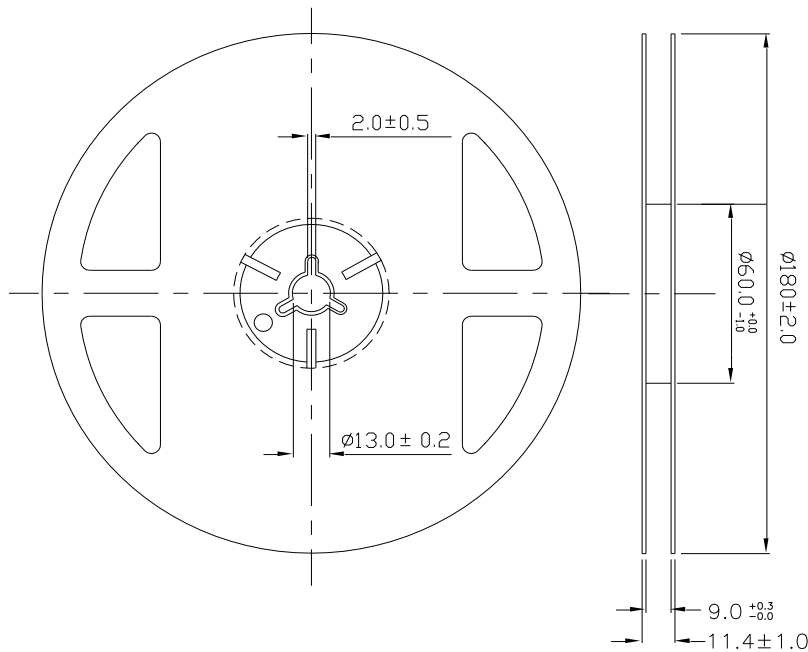

Note:
 Tolerances unless mentioned ± 0.1 mm. Unit = mm

Carrier Tape Dimensions: Loaded Quantity 500/1000/1500/2000/2500/3000/3500/4000 pcs
Per Reel

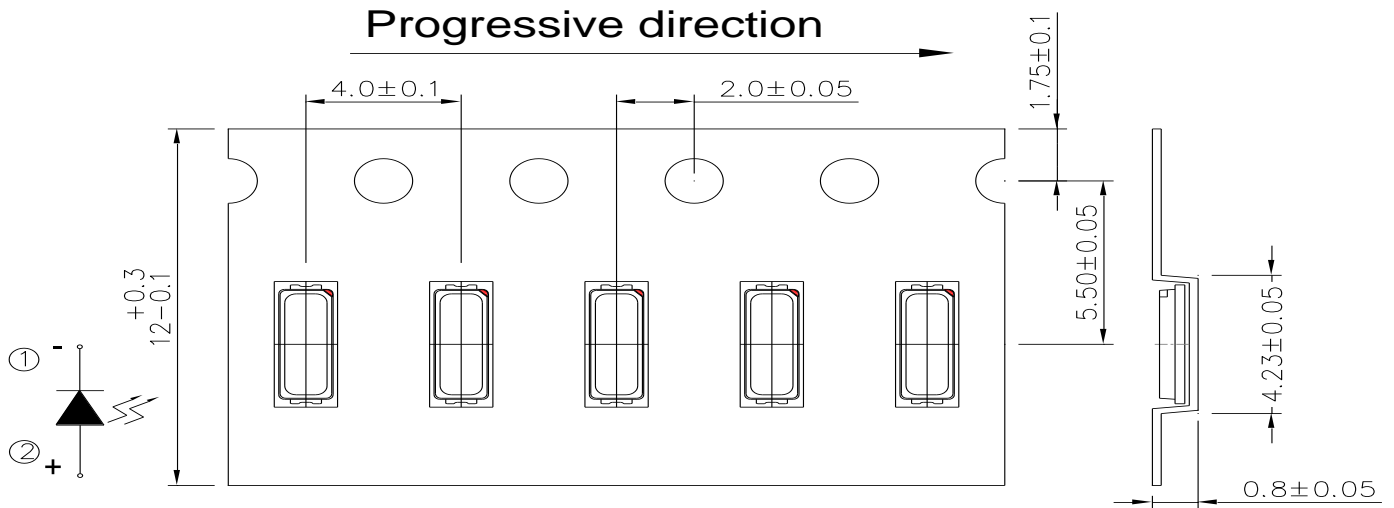

Note:
1. Tolerance unless mentioned is ± 0.1 mm; Unit = mm

Moisture Resistant Packing Process

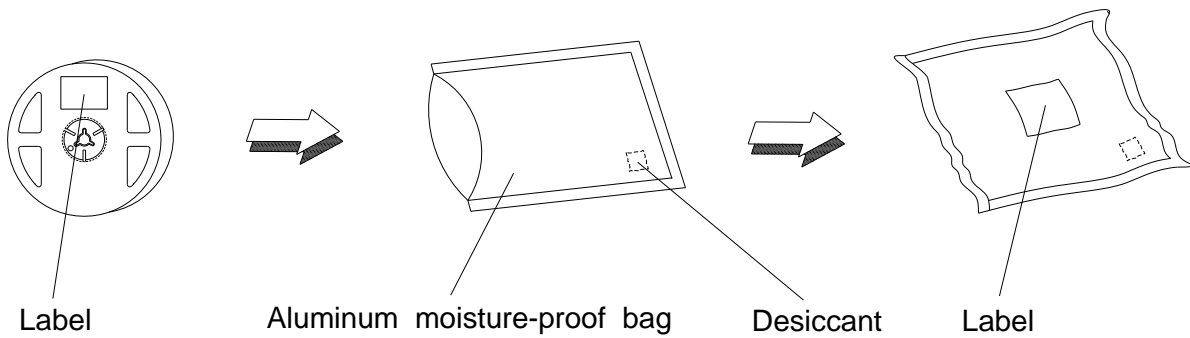

Reliability Test Items and Conditions

The reliability of products shall be satisfied with items listed below.
 Confidence level : 90%
 LTPD : 10%

No.	Items	Test Condition	Test Hours/Cycles	Sample Size	Ac/Re
1	Resistance to Solder Heat	Temp. : 260°C/10sec.	3 Times.	8 PCS.	0/1
2	Temperature Cycle	-40°C~100°C / Dwell time 30min	200 Cycles	8 PCS.	0/1
3	High Temperature/Humidity Life	Ta=85°C,85%RH, I _F = 75mA	1000 Hrs.	8 PCS.	0/1
4	Low Temperature Life	Ta=-40°C, I _F = 75 mA	1000 Hrs.	8 PCS.	0/1
5	High Temperature Life	Ta=60°C, I _F =75mA	3000 Hrs.	8 PCS.	0/1
6	High Temperature Life	Ta=85°C, I _F =75 mA	3000 Hrs.	8 PCS.	0/1
7	Pulse	ON 30ms / OFF 2500ms	30000 CYCLES	8 PCS.	0/1
8	Thermal Shock	H : +100°C 20min ∩ 10 sec L : -40°C 20min	200 Cycles	8 PCS.	0/1
9	Power Temperature Cycle	H : +100°C 15min ∩ 5 min L : -40°C 15min I _F = 50 mA	200 Cycles	8 PCS.	0/1

Precautions for Use

1. Over-current-proof

Customer must apply resistors for protection; otherwise slight voltage shift will cause big current change (Burn out will happen).

2. Storage

2.1 Do not open moisture proof bag before the products are ready to use.

2.2 Before opening the package: The LEDs should be kept at 30°C or less and 90%RH or less.

2.3 After opening the package: The LED's floor life is 168 Hrs under 30°C or less and 60% RH or less. If unused LEDs remain, it should be stored in moisture proof packages.

2.4 If the moisture absorbent material (silica gel) has faded away or the LEDs have exceeded the storage time, baking treatment should be performed using the following conditions.

Baking treatment: 60±5°C for 24 hours.

3. Soldering Condition

3.1 Pb-free solder temperature profile

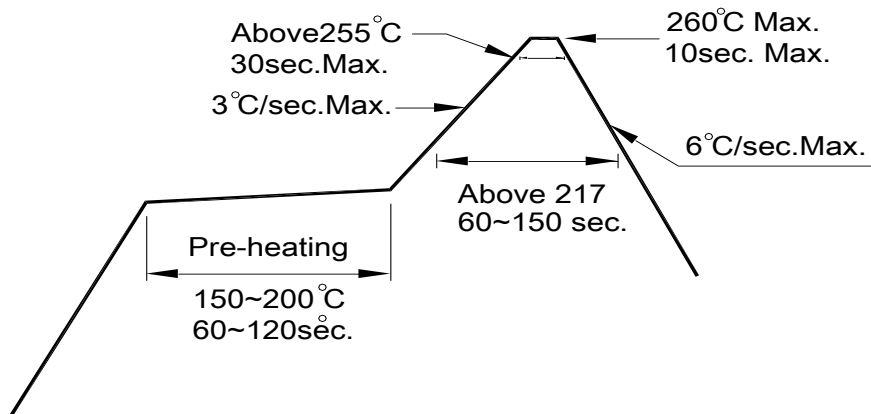

3.2 Reflow soldering should not be done more than two times.

3.3 When soldering, do not put stress on the LEDs during heating.

3.4 After soldering, do not warp the circuit board.

4. Soldering Iron

Each terminal is to go to the tip of soldering iron temperature less than 350°C for 3 seconds within once in less than the soldering iron capacity 25W. Leave two seconds and more intervals, and do soldering of each terminal. Be careful because the damage of the product is often started at the time of the hand solder.

5. Repairing

Repair should not be done after the LEDs have been soldered. When repairing is unavoidable, a double-head soldering iron should be used (as below figure). It should be confirmed beforehand whether the characteristics of the LEDs will or will not be damaged by repairing.

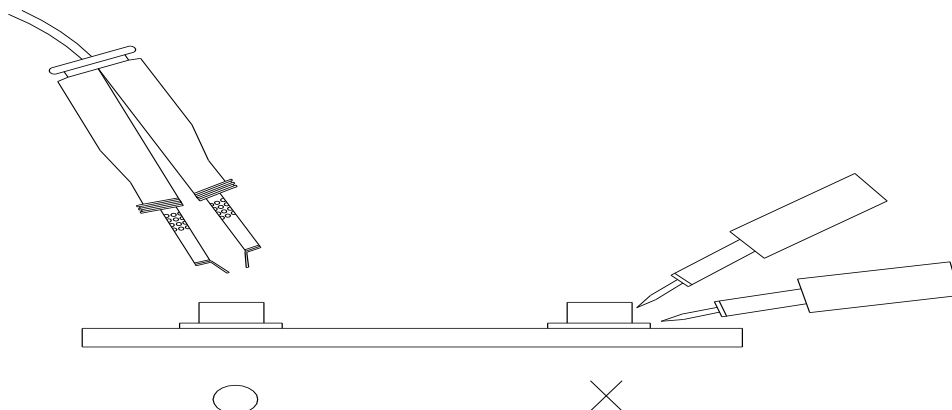

DISCLAIMER

1. EVERLIGHT reserves the right(s) on the adjustment of product material mix for the specification.
2. The product meets EVERLIGHT published specification for a period of twelve (12) months from date of shipment.
3. The graphs shown in this datasheet are representing typical data only and do not show guaranteed values.
4. When using this product, please observe the absolute maximum ratings and the instructions for using outlined in these specification sheets. EVERLIGHT assumes no responsibility for any damage resulting from the use of the product which does not comply with the absolute maximum ratings and the instructions included in these specification sheets.
5. These specification sheets include materials protected under copyright of EVERLIGHT. Reproduction in any form is prohibited without obtaining EVERLIGHT's prior consent.
6. This product is not intended to be used for military, aircraft, automotive, medical,