

SMD ▪ Top View LEDs

BL-7020NZ1TH3C-L1OFD3259D2832



Features

- Top View White LEDs
- Wide viewing angle
- Soldering methods: IR reflow soldering
- Pb-free
- The product itself will remain within RoHS compliant version.
- Compliance with EU REACH.
- Compliance Halogen Free .(Br <900 ppm ,Cl <900 ppm , Br+Cl < 1500 ppm).

Description

Due to the package design, 62-119 has wide viewing angle, low power consumption and white LEDs are devices which are materialized by combing blue chips and special phosphor. This feature makes the LED ideal for light guide application.

Applications

- Backlight for LCD Monitor/TV
- Light pipe application
- Indicator and backlight in office and family equipment
- General use

Device Selection Guide

Chip Materials	Emitted Color	Resin Color
InGaN	White	Water Clear

Absolute Maximum Ratings ($T_a=25^{\circ}\text{C}$)

Parameter	Symbol	Rating	Unit
Forward Current	I_F	140	mA
Peak Forward Current (Duty 1/10 @10ms)	I_{FP}	280	mA
Power Dissipation	P_d	448	mW
Electrostatic Discharge(HBM) ^{*1}	ESD	5000	V
Operating Temperature	T_{opr}	-40 ~ +85	$^{\circ}\text{C}$
Storage Temperature	T_{stg}	-40 ~ +90	$^{\circ}\text{C}$
Junction Temperature	T_j	115	$^{\circ}\text{C}$
Soldering Temperature	T_{sol}	Reflow Soldering : 260 $^{\circ}\text{C}$ for 10 sec. Hand Soldering : 350 $^{\circ}\text{C}$ for 3 sec.	

Notes: ^{*1}The products are sensitive to static electricity and must be carefully taken when handling products.

Electro-Optical Characteristics ($T_a=25^{\circ}\text{C}$)

Parameter	Symbol	Min.	Typ.	Max.	Unit	Condition
Luminous Flux	Φ	32	-----	60	lm	$I_F=120\text{mA}$
Forward Voltage	V_F	2.80	-----	3.30	V	$I_F=120\text{mA}$
Viewing Angle	$2\theta_{1/2}$	-----	120	-----	deg	$I_F=120\text{mA}$

Notes:

1. Tolerance of Luminous flux: $\pm 7\%$.
2. Tolerance of Forward Voltage: $\pm 0.05\text{V}$.

Bin Range of Luminous Flux

Bin Code	Min.	Max.	Unit	Condition
D32	32	33		
D33	33	34		
D34	34	35		
D35	35	36		
D36	36	37		
D37	37	38		
D38	38	39		
D39	39	40		
D40	40	41		
D41	41	42		
D42	42	43		
D43	43	44		
D44	44	45		
D45	45	46		
D46	46	47	lm	I _F =120mA
D47	47	48		
D48	48	49		
D49	49	50		
D50	50	51		
D51	51	52		
D52	52	53		
D53	53	54		
D54	54	55		
D55	55	56		
D56	56	57		
D57	57	58		
D58	58	59		
D59	59	60		

Note: Tolerance of Luminous flux: ±7%

Bin Range of Forward Voltage

Bin Code	Min.	Max.	Unit	Condition
D28	2.80	2.90	V	I _F =120mA
D29	2.90	3.00		
D30	3.00	3.10		
D31	3.10	3.20		
D32	3.20	3.30		

Notes: Tolerance of Forward Voltage: ±0.05V

Bin Range of Chromaticity Coordinate

Bin Code	CIE_x	CIE_y	Bin Code	CIE_x	CIE_y
L1	0.2335	0.2035	L9	0.2655	0.2707
	0.2423	0.1987		0.2743	0.2659
	0.2383	0.1903		0.2703	0.2575
	0.2295	0.1951		0.2615	0.2623
L2	0.2375	0.2119	LA	0.2695	0.2791
	0.2463	0.2071		0.2783	0.2743
	0.2423	0.1987		0.2743	0.2659
	0.2335	0.2035		0.2655	0.2707
L3	0.2415	0.2203	LB	0.2735	0.2875
	0.2503	0.2155		0.2823	0.2827
	0.2463	0.2071		0.2783	0.2743
	0.2375	0.2119		0.2695	0.2791
L4	0.2455	0.2287	LC	0.2775	0.2959
	0.2543	0.2239		0.2863	0.2911
	0.2503	0.2155		0.2823	0.2827
	0.2415	0.2203		0.2735	0.2875
L5	0.2495	0.2371	LD	0.2815	0.3043
	0.2583	0.2323		0.2903	0.2995
	0.2543	0.2239		0.2863	0.2911
	0.2455	0.2287		0.2775	0.2959
L6	0.2535	0.2455	LE	0.2855	0.3127
	0.2623	0.2407		0.2943	0.3079
	0.2583	0.2323		0.2903	0.2995
	0.2495	0.2371		0.2815	0.3043
L7	0.2575	0.2539	LF	0.2895	0.3211
	0.2663	0.2491		0.2983	0.3163
	0.2623	0.2407		0.2943	0.3079
	0.2535	0.2455		0.2855	0.3127
L8	0.2615	0.2623			
	0.2703	0.2575			
	0.2663	0.2491			
	0.2575	0.2539			

Notes: Tolerance of Chromaticity Coordinates: ± 0.005

Bin Range of Chromaticity Coordinate

Bin Code	CIE_x	CIE_y	Bin Code	CIE_x	CIE_y
M1	0.2423	0.1987	M9	0.2743	0.2659
	0.2511	0.1939		0.2831	0.2611
	0.2471	0.1855		0.2791	0.2527
M2	0.2383	0.1903	MA	0.2703	0.2575
	0.2463	0.2071		0.2783	0.2743
	0.2551	0.2023		0.2871	0.2695
M3	0.2511	0.1939	MB	0.2831	0.2611
	0.2423	0.1987		0.2743	0.2659
	0.2503	0.2155		0.2823	0.2827
M4	0.2591	0.2107	MC	0.2911	0.2779
	0.2551	0.2023		0.2871	0.2695
	0.2463	0.2071		0.2783	0.2743
M5	0.2543	0.2239	MD	0.2863	0.2911
	0.2631	0.2191		0.2951	0.2863
	0.2591	0.2107		0.2911	0.2779
M6	0.2503	0.2155	ME	0.2823	0.2827
	0.2583	0.2323		0.2903	0.2995
	0.2671	0.2275		0.2991	0.2947
M7	0.2631	0.2191	MF	0.2951	0.2863
	0.2543	0.2239		0.2863	0.2911
	0.2623	0.2407		0.2943	0.3079
M8	0.2711	0.2359		0.3031	0.3031
	0.2671	0.2275		0.2991	0.2947
	0.2583	0.2323		0.2903	0.2995
	0.2663	0.2491		0.2983	0.3163
	0.2751	0.2443		0.3071	0.3115
	0.2711	0.2359		0.3031	0.3031
	0.2623	0.2407		0.2943	0.3079
	0.2703	0.2575			
	0.2791	0.2527			
	0.2751	0.2443			
	0.2663	0.2491			

Notes: Tolerance of Chromaticity Coordinates: ± 0.005

Bin Range of Chromaticity Coordinate

Bin Code	CIE_x	CIE_y	Bin Code	CIE_x	CIE_y
N1	0.2511	0.1939	N9	0.2831	0.2611
	0.2599	0.1891		0.2919	0.2563
	0.2559	0.1807		0.2879	0.2479
	0.2471	0.1855		0.2791	0.2527
N2	0.2551	0.2023	NA	0.2871	0.2695
	0.2639	0.1975		0.2959	0.2647
	0.2599	0.1891		0.2919	0.2563
	0.2511	0.1939		0.2831	0.2611
N3	0.2591	0.2107	NB	0.2911	0.2779
	0.2679	0.2059		0.2999	0.2731
	0.2639	0.1975		0.2959	0.2647
	0.2551	0.2023		0.2871	0.2695
N4	0.2631	0.2191	NC	0.2951	0.2863
	0.2719	0.2143		0.3039	0.2815
	0.2679	0.2059		0.2999	0.2731
	0.2591	0.2107		0.2911	0.2779
N5	0.2671	0.2275	ND	0.2991	0.2947
	0.2759	0.2227		0.3079	0.2899
	0.2719	0.2143		0.3039	0.2815
	0.2631	0.2191		0.2951	0.2863
N6	0.2711	0.2359	NE	0.3031	0.3031
	0.2799	0.2311		0.3119	0.2983
	0.2759	0.2227		0.3079	0.2899
	0.2671	0.2275		0.2991	0.2947
N7	0.2751	0.2443	NF	0.3071	0.3115
	0.2839	0.2395		0.3159	0.3067
	0.2799	0.2311		0.3119	0.2983
	0.2711	0.2359		0.3031	0.3031
N8	0.2791	0.2527			
	0.2879	0.2479			
	0.2839	0.2395			
	0.2751	0.2443			

Notes: Tolerance of Chromaticity Coordinates: ± 0.005

Bin Range of Chromaticity Coordinate

Bin Code	CIE_x	CIE_y	Bin Code	CIE_x	CIE_y
O1	0.2599	0.1891	O9	0.2919	0.2563
	0.2687	0.1843		0.3007	0.2515
	0.2647	0.1759		0.2967	0.2431
	0.2559	0.1807		0.2879	0.2479
O2	0.2639	0.1975	OA	0.2959	0.2647
	0.2727	0.1927		0.3047	0.2599
	0.2687	0.1843		0.3007	0.2515
	0.2599	0.1891		0.2919	0.2563
O3	0.2679	0.2059	OB	0.2999	0.2731
	0.2767	0.2011		0.3087	0.2683
	0.2727	0.1927		0.3047	0.2599
	0.2639	0.1975		0.2959	0.2647
O4	0.2719	0.2143	OC	0.3039	0.2815
	0.2807	0.2095		0.3127	0.2767
	0.2767	0.2011		0.3087	0.2683
	0.2679	0.2059		0.2999	0.2731
O5	0.2759	0.2227	OD	0.3079	0.2899
	0.2847	0.2179		0.3167	0.2851
	0.2807	0.2095		0.3127	0.2767
	0.2719	0.2143		0.3039	0.2815
O6	0.2799	0.2311	OE	0.3119	0.2983
	0.2887	0.2263		0.3207	0.2935
	0.2847	0.2179		0.3167	0.2851
	0.2759	0.2227		0.3079	0.2899
O7	0.2839	0.2395	OF	0.3159	0.3067
	0.2927	0.2347		0.3247	0.3019
	0.2887	0.2263		0.3207	0.2935
	0.2799	0.2311		0.3119	0.2983
O8	0.2879	0.2479			
	0.2967	0.2431			
	0.2927	0.2347			
	0.2839	0.2395			

Notes: Tolerance of Chromaticity Coordinates: ± 0.005

The C.I.E. 1931 Chromaticity Diagram

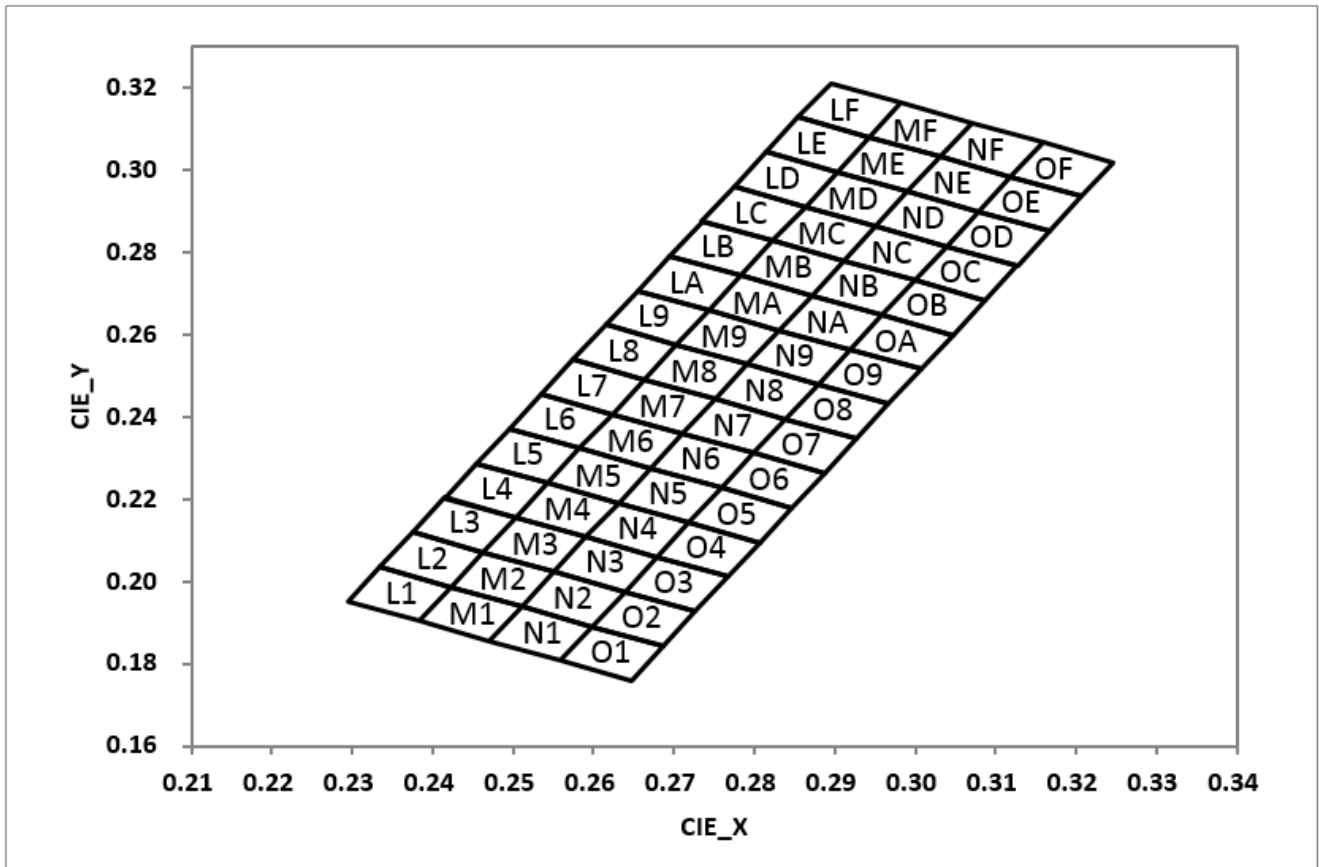

Package Outline Dimensions

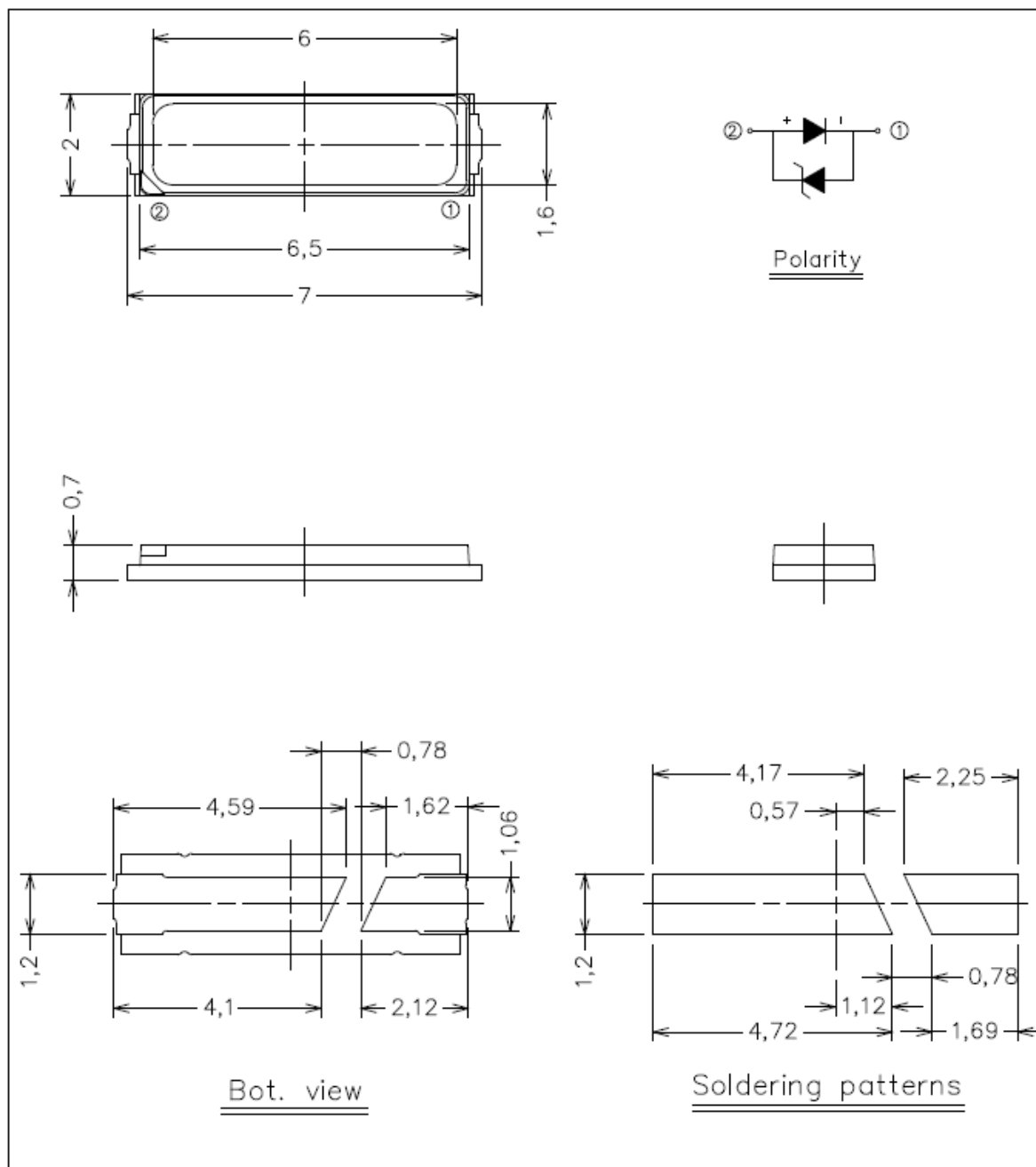

Note: Tolerances unless dimension are ± 0.1 mm, unit = mm.

Typical Electro-Optical-Thermal Characteristics Curves

1. Spectrum Distribution

($T_a=25^\circ\text{C}$, $I_f=120\text{mA}$)

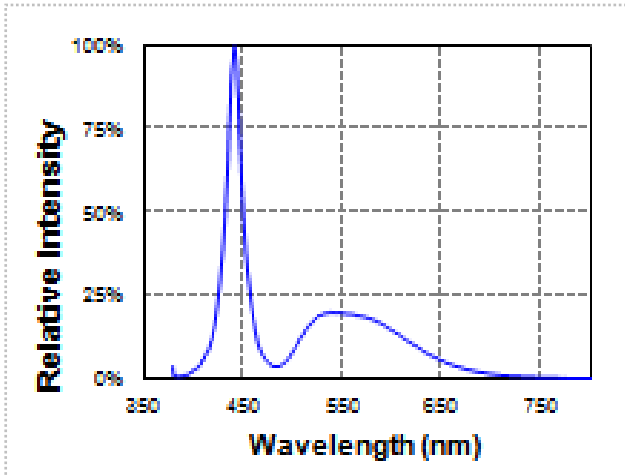

2. Relative Luminous Flux vs. Forward Current

($T_a=25^\circ\text{C}$)

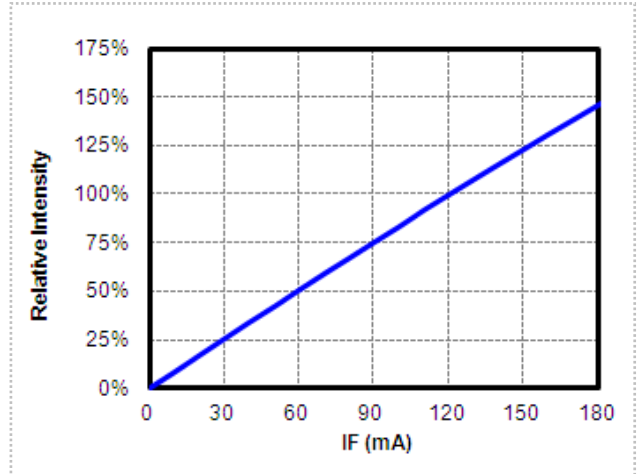

3. Relative Forward Voltage vs. Forward Current

($T_a=25^\circ\text{C}$)

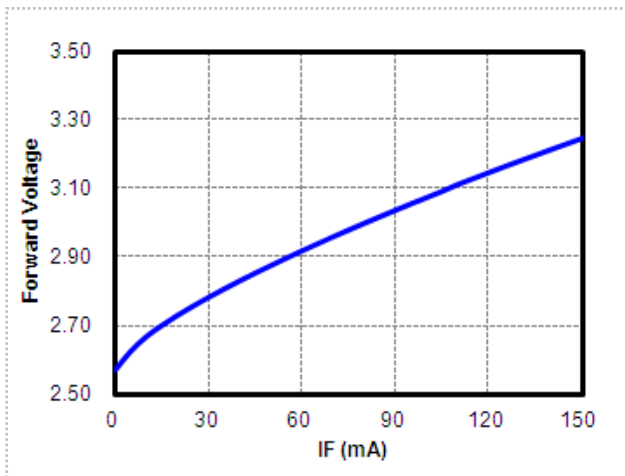

4. Radiation Diagram

($T_a=25^\circ\text{C}$, $I_f=120\text{mA}$)

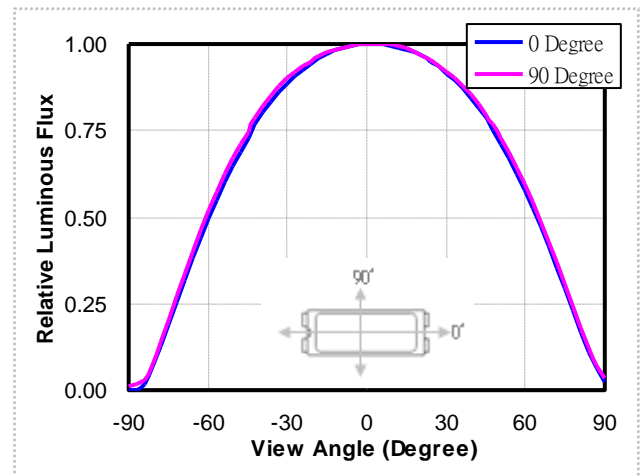

Typical Electro-Optical-Thermal Characteristics Curves

5. Relative Luminous Flux vs. Ambient Temperature
($I_F=120\text{mA}$)

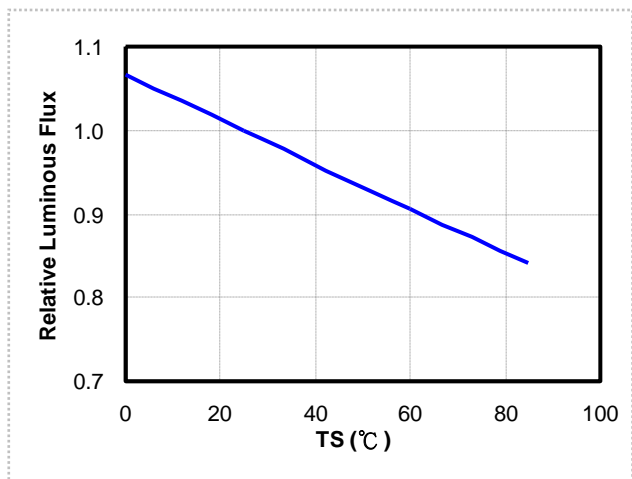

6. Forward Voltage vs. Ambient Temperature
($I_F=120\text{mA}$)

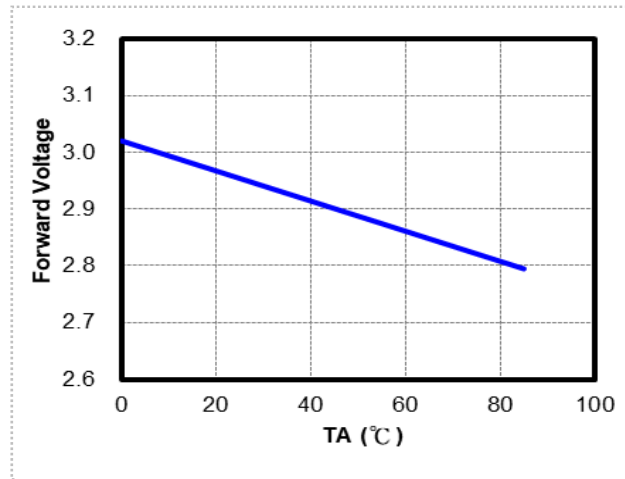

7. Chromaticity Coordinates vs. Ambient Temperature
($I_F=75\text{mA}$)

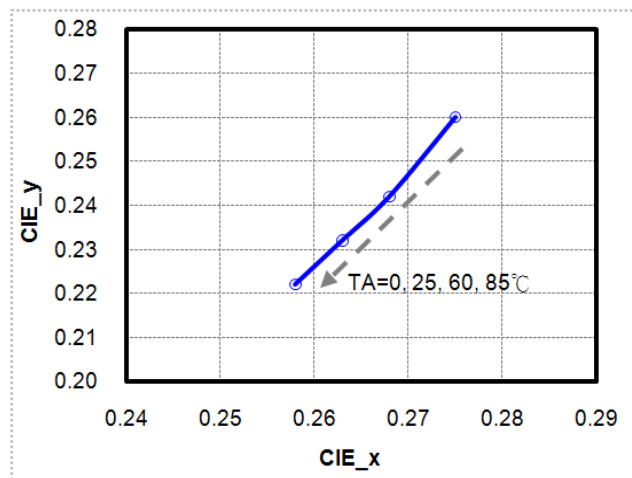

8. Forward Current De-rating Curve

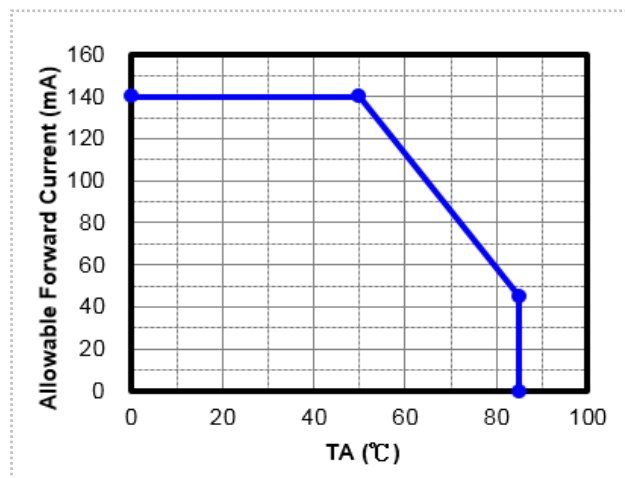

Moisture Resistant Packing Materials

Label Explanation

CAT: Luminous Flux Rank

HUE: Chromaticity Coordinates

REF: Forward Voltage Rank

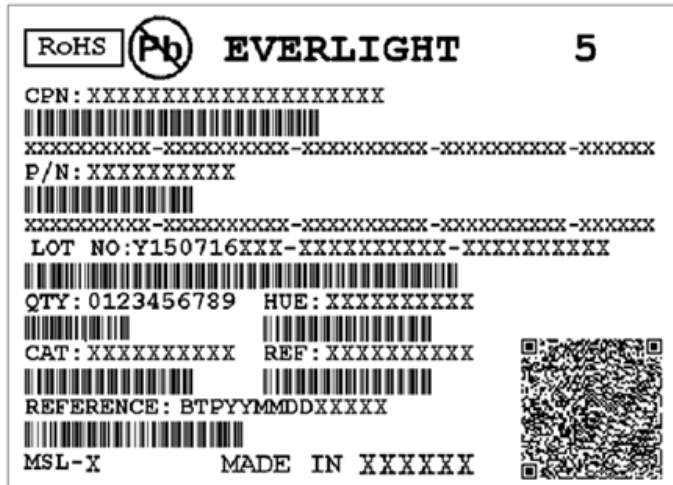

Reel Dimensions

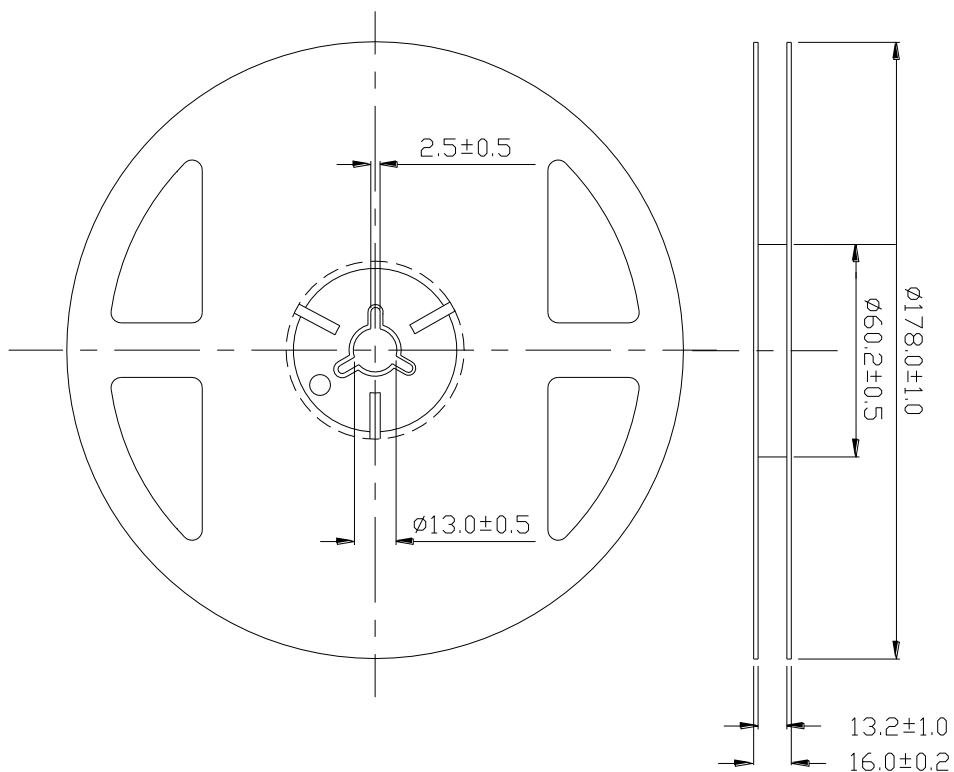

Note: Tolerances unless mentioned ± 0.1 mm. Unit = mm

Carrier Tape Dimensions: Loaded Quantity 250 up/500/1000/2000 pcs. Per Reel

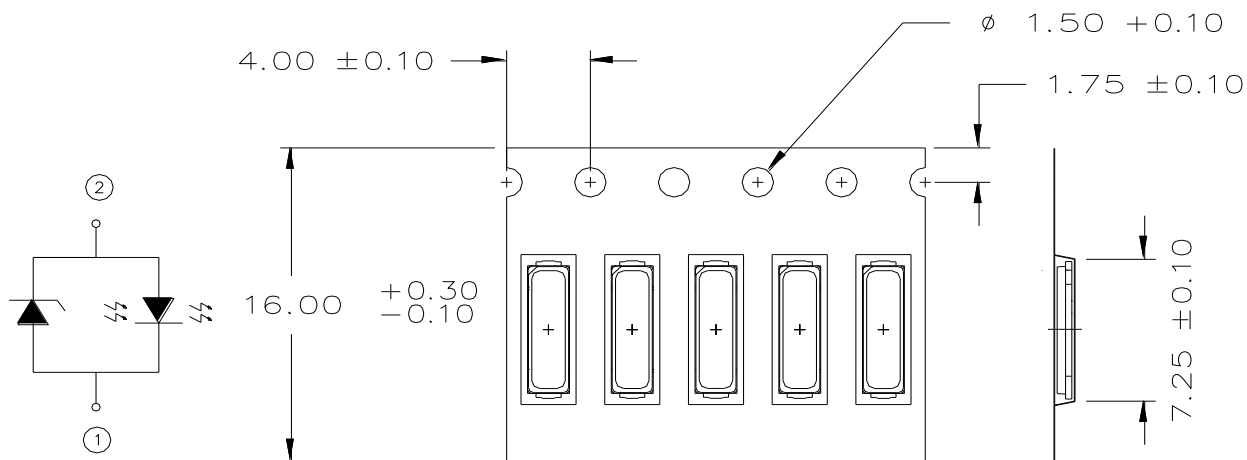

Note: The tolerances unless mentioned is ± 0.1 mm; Unit = mm

Moisture Resistant Packaging

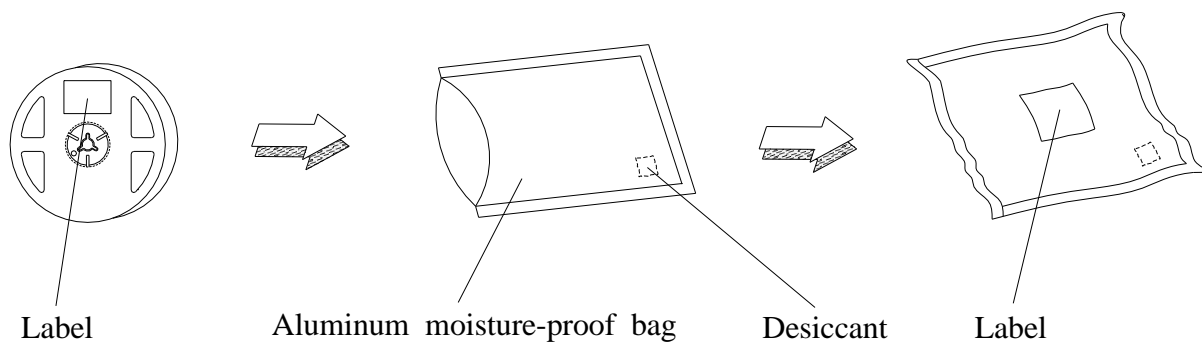

Reliability Test Items and Conditions

The reliability of products shall be satisfied with items listed below.

Confidence level : 90%

LTPD : 10%

No.	Item	Test Conition		Test Hours/ Times	Criteria (at std. IF)
		Temp./ Humidity	IF (mA)		
1	Reflow Soldering	Temp.: 260°C±5°C Max. 10 sec.		2 time	ΔIv < ±10% ΔVF < ±10%
2	Temperature Cycle	-40°C 30min.	~ (5min.)	100°C 30min.	200 cycles
3	Thermal Shock	-10°C 20min.	~ (<15sec.)	100°C 20min.	200 cycles
4	Low Temp. Storage	TA=-40°C	--	1000 hrs	
5	High Temp. Storage	TA=100°C	--	1000 hrs	
6	Temp. Humidity Storage	TA=60°C/ 90%RH	--	1000 hrs	
7	Steady State Operating Life of Low Temp.	TA=-40°C	120	1000 hrs	Iv > 70%, VF < 110%,
8	Steady State Operating Life Condition 1	TA=25°C/ Room Hum.	120	1000 hrs	
9	Steady State Operating Life Condition 2	TA=60°C	120	1000 hrs	
10	Steady State Operating Life of High Temp.	TA=85°C	45	1000 hrs	
11	Steady State Operating Life of High Humidity Heat	TA=60°C/ 90%RH	120	1000 hrs	

Notes:

1. Sampling for each test item: 22 (pcs)

2. Test board: MCPCB board thickness=1.6mm, copper layer thickness=0.07mm, Rth j-a = 90°C/W.

3. Measurements are performed after allowing the LEDs to return to room temperature.

Precautions for Use

1. Over-current-proof

Customer must apply resistors for protection, otherwise slight voltage shift will cause big current change (Burn out will happen).

2. Storage

2.1 Do not open moisture proof bag before the products are ready to use.

2.2 Before opening the package: The LEDs should be used within one year and kept at 30°C or less and 70%RH or less.

2.3 After opening the package: We recommend that the LED should be soldered quickly (within 3 days). The soldering condition is 30°C or less and 60%RH or less. If unused LEDs remain, it should be stored in moisture proof packages.

2.4 If the moisture absorbent material (silica gel) has faded away or the LEDs have exceeded the storage time, baking treatment should be performed using the following conditions.

Baking treatment: 60±5°C for 24 hours. (One time only)

3. Soldering Condition

3.1 Pb-free solder temperature profile

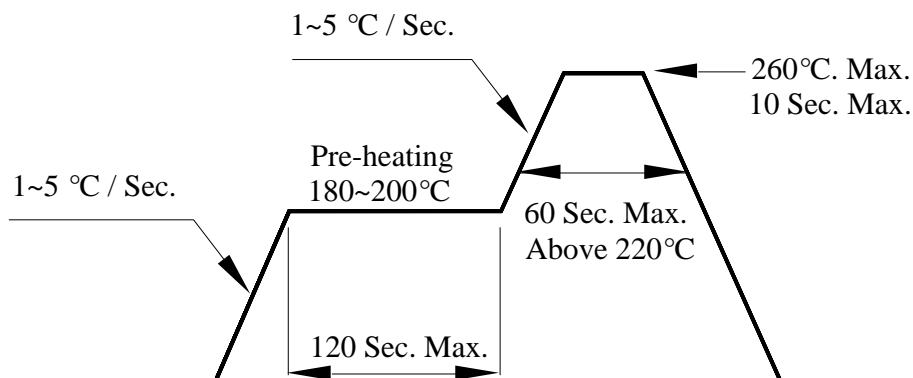

3.2 Reflow soldering should not be done more than two times.

3.3 When soldering, do not put stress on the LEDs during heating.

3.4 After soldering, do not warp the circuit board.

4. Soldering Iron

Each terminal is to go to the tip of soldering iron temperature less than 350°C for 3 seconds within once in less than the soldering iron capacity 25W. Leave two seconds and more intervals, and do soldering of each terminal. Be careful because the damage of the product is often started at the time of the hand solder.

5. Repairing

Repair should not be done after the LEDs have been soldered. When repairing is unavoidable, a double-head soldering iron should be used (as below figure). It should be confirmed beforehand whether the characteristics of the LEDs will or will not be damaged by repairing.

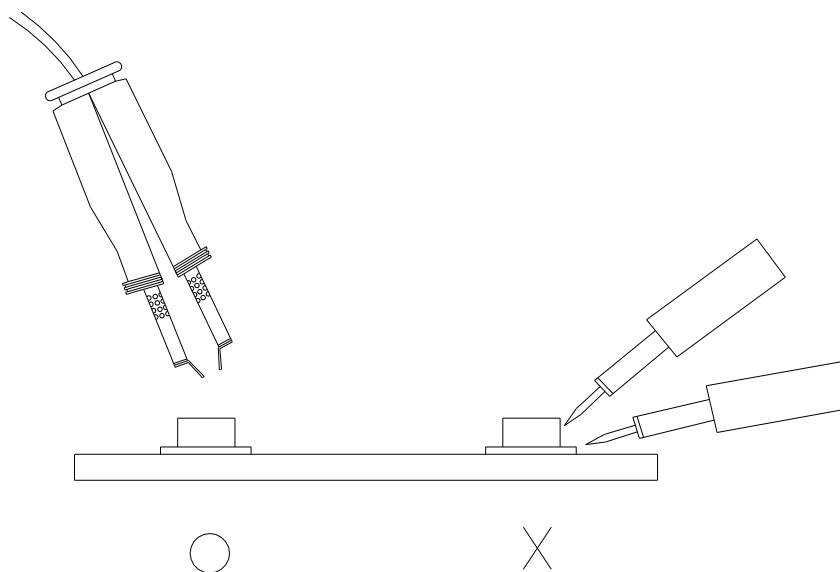

6. Handling Indications

During processing, mechanical stress on the surface should be minimized as much as possible. Sharp objects of all types should not be used to pierce the sealing compound.

Notice

This product is licensed by National Institute for Materials Science (NIMS) for Japan Pat. No. 3975451, U.S. Pat. Nos. 7,678,294, TW Pat. No. I-299055, Pat. App. Nos. US12/096,601, DE112005000044T5, ZL200580000742.3, KR10-2007-0021140, JP2007-549180, or EP1964905.